

Article number: 2301072931

Description: E+G Handwheel  
VDS.250+IRS-A20

## Measures

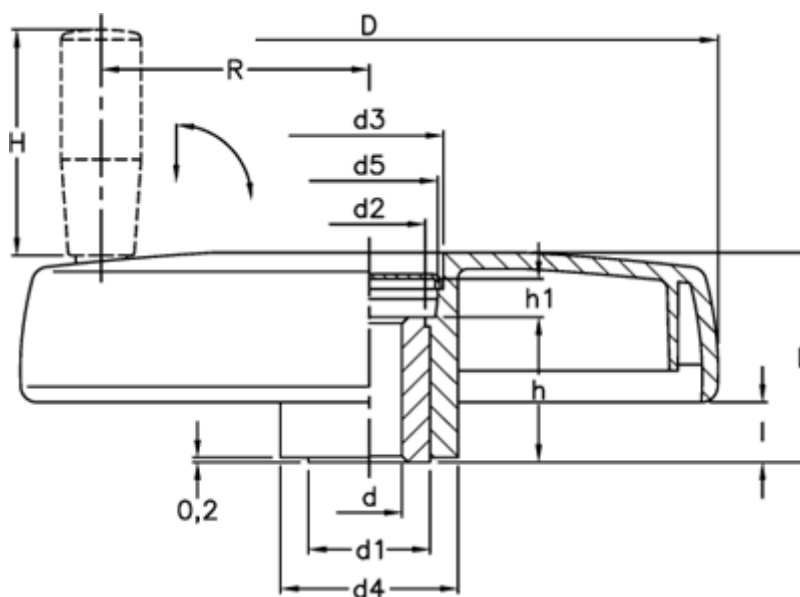

C (N m) = 500	H = 90
D = 250	h = 36
d1 = 40	h1 = 19
d2 = 38.0	l = 17
d3 = 50.0	L = 60
d4 = 57	L (J) = 30
d5 = 48	R = 104
d H7 = 20	